

A strong customer connection

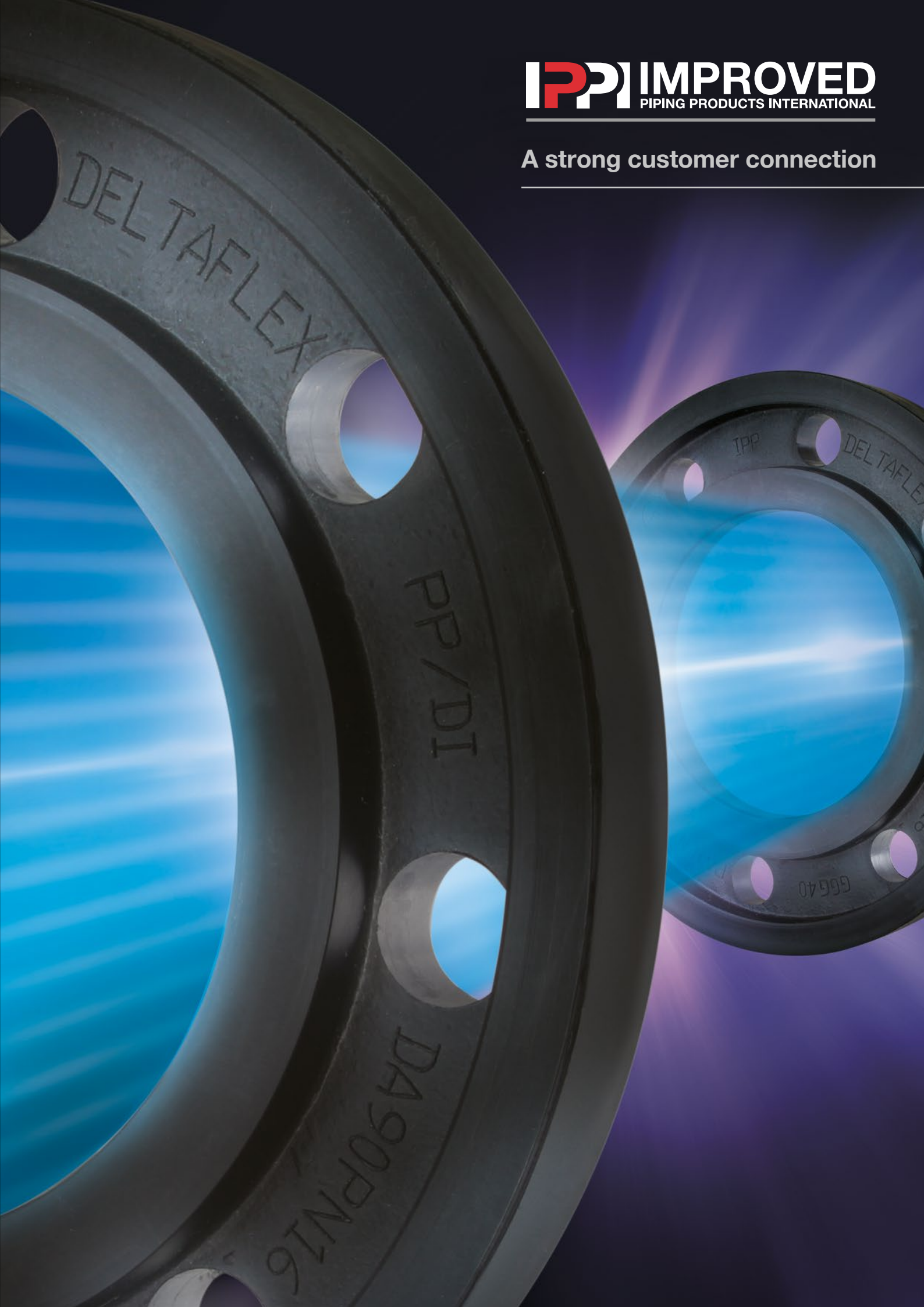

# History

Improved Piping Product, Inc. (IPPI), is a thriving family business created by Gunter Schlicht in 1979. The business is now run by his two sons.

We are famous for our products called Deltaflex<sup>®</sup>, convoluted high quality pipe flanges. IPPI is established as a world leader in the engineering, design, manufacture and distribution of piping flange systems.

With all these years of piping experience with the Deltaflex<sup>®</sup> convoluted flange design, we have been instrumental in bringing reduced costs and increased performance to flanging systems.

Deltaflex<sup>®</sup> products are used for water, mining, gas, marine applications and fish farming and our customers are typically either pipe manufacturers, pipe fitting manufacturers or distributors. IPPI have customers in more than 25 countries and the number is growing.

IPPI's warehouse is located in central Europe where we hold full stock of our product range. We send goods out daily and offer a delivery time of between 2 to 7 days depending on your location. We have sales offices based in Denmark and the UK with customer support ready to help you wherever you are located.

## a strong customer connection



**Deltaflex<sup>®</sup>**  
Flanges



## Benefits

Convoluted shape = bolts do not lose tension, no need for re-torquing when installed correctly

Lightweight, app 40% lighter than standard flat plate flanges

- a) Easy to install
- b) Reduced transport costs

No corrosion – ideal in most corrosive atmospheres where plain steel will corrode

**These factors alone mean cost saving at all stages from purchase, transportation, installation and reduced maintenance.**

Operating pressure is stated on the flanges

Flanges have a safety factor of 2

Available from d20mm up to d1600mm in metric range and from 2" to 66" in ANSI range

Adaptable to steel and all thermoplastic piping systems.

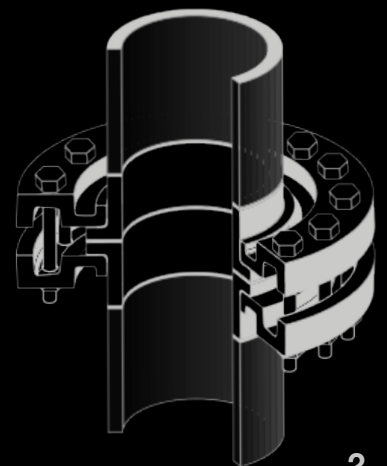

## Polypropylene Encapsulated Ductile Iron (PP/Steel) Flange

For butt welding



■ Polypropylene  
■ Ductile Iron

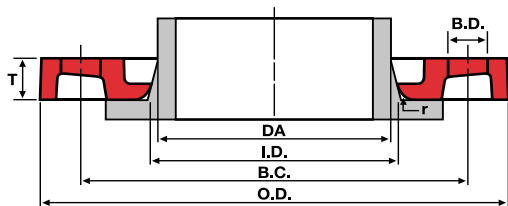

**Description** PP encapsulated Ductile Iron Deltaflex® convoluted flange

Utilises the IPP Deltaflex® flange cross section, highly corrosion resistant.

**Utilisation** For use on PE, PP, PVDF butt welding stub ends.

**Materials** Glass reinforced Polypropylene (black) with IPP Deltaflex® Ductile Iron insert (GGG 40, DIN 1693)

**Connecting Dimensions** Drilled to ISO/DIN 2501 (EN1092) standard  
DA 20-1000mm : drilled PN10  
DA 200, 225, 250, 315, 400, 560 & 630mm : drilled PN16

**Must use appropriate washers with the Flanges**

DA (mm)	DN (mm)	Code	Outside Dia. O.D.	Inside Dia. I.D.	Flange Thickness T	Bolt Circle B.C.	Bolt Hole B.D.	Bolt Count N	Bolt Size M	Radius r	Operating Pressure max. [bar]	Weight kg/pc.
20	15	PPDA 20-10	106	28	18	65	14	4	M12	3	16	0,4
25	20	PPDA 25-10	118	34	18	75	14	4	M12	3	16	0,4
32	25	PPDA 32-10	122	42	17	85	14	4	M12	3	16	0,4
40	32	PPDA 40-10	142	51	17	100	18	4	M16	3	16	0,5
50	40	PPDA 50-10	156	62	19	110	18	4	M16	3	16	0,7
63	50	PPDA 63-10	171	78	20	125	18	4	M16	3	16	0,9
75	65	PPDA 75-10	191	92	21	145	18	4	M16	3	16	1,0
90	80	PPDA 90-10	206	108	21	160	18	8	M16	3	16	1,1
110	100	PPDA 110-10	226	128	22	180	18	8	M16	3	16	1,5
125	100	PPDA 125-10	226	135	23	180	18	8	M16	3	16	1,4
140	125	PPDA 140-10	261	158	25	210	18	8	M16	3	16	1,7
160	150	PPDA 160-10	296	178	28	240	22	8	M20	3	16	1,8
180	150	PPDA 180-10	296	188	27	240	22	8	M20	4	16	1,9
200	200	PPDA 200-10	350	235	32	295	22	8	M20	4	10	3,1
200	200	PPDA 200-16	350	235	32	295	22	12	M20	4	16	3,27
225	200	PPDA 225-10	350	238	31	295	22	8	M20	4	10	3,1
225	225	PPDA 225-16	350	238	31	295	22	12	M20	4	16	3,05
250	250	PPDA 250-10	412	288	36	350	22	12	M20	4	10	4,9
250	250	PPDA 250-16	420	288	36	355	26	12	M24	3	16	5,12
280	250	PPDA 280-10	412	294	35	350	22	12	M20	4	10	4,4
315	300	PPDA 315-10	462	338	42	400	22	12	M20	4	10	6,4
315	300	PPDA 315-16	476	338	42	410	26	12	M24	3	16	6,69
355	350	PPDA 355-10	525	376	52	460	22	16	M20	6	10	11,1
400	400	PPDA 400-10	586	430	56	515	26	16	M24	6	10	14,7
400	400	PPDA 400-16	600	430	56	525	30	16	M27	6	16	12,32
450	500	PPDA 450-10	690	514	54,5	620	27	20	M24	6	10	20,3
500	500	PPDA 500-10	690	530	55	620	27	20	M24	6	10	19,2
560	600	PPDA 560-10	804	615	62	725	30	20	M27	6	10	30
560	600	PPDA 560-16	856	618	114	770	36	20	M33	5	16	73,0
630	600	PPDA 630-10	804	642	62	725	30	20	M27	6	10	27,7
630	600	PPDA 630-16	856	645	114	770	36	20	M33	5	16	76,8
710	700	PPDA 710-10	912	740	49	840	30	24	M27	5	6	28,6
800	800	PPDA 800-10	1026	843	58	950	33	24	M30	5	6	39,3
900	900	PPDA 900-10	1129	947	62	1050	33	28	M30	5	6	48,5
1000	1000	PPDA 1000-10	1245	1050	70	1160	36	28	M33	5	6	60,0

For  
socket  
welding



■ Polypropylene  
■ Ductile Iron

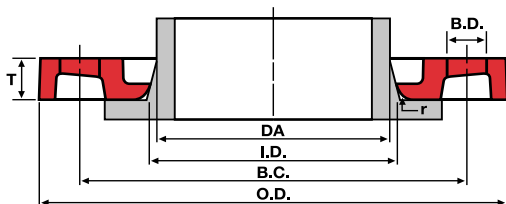

## Polypropylene Encapsulated Ductile Iron (PP/Steel)

**Description** PP encapsulated Ductile Iron Deltaflex® convoluted flange

Utilises the IPP Deltaflex® flange cross section, highly corrosion resistant.

**Utilisation** For use on PVC-U, PVC-C, ABS, PE, PP, PVDF **socket welded stub ends**

**Materials** 30% Glass reinforced Polypropylene (black) with IPP Deltaflex® Ductile Iron insert (GGG 40, DIN 1693)

**Connecting Dimensions** Drilled to ISO/DIN 2501 (EN1092)  
DA 20 - 180mm: Drilled PN 10/16  
> DA 180mm: Drilled PN 10

**Must use appropriate washers with the Flanges**

DA	DN	Code	Outside Dia.	Inside Dia.	Flange Thickness	Bolt Circle	Bolt Hole	Bolt Count	Bolt Size	Radius	Operating Pressure	Weight
(mm)	(mm)		O.D.	I.D.	T	B.C.	B.D.	N	M	r	max. [bar]	kg/pc.
20	15	PPDA 20-10*	106	28	18	65	14	4	M12	3	16	0,4
25	20	PPDA 25-10*	118	34	18	75	14	4	M12	3	16	0,4
32	25	PPDA 32-10*	122	42	17	85	14	4	M12	3	16	0,4
40	32	PPDA 40-10*	142	51	17	100	18	4	M16	3	16	0,5
50	40	PPDA 50-10*	156	62	19	110	18	4	M16	3	16	0,7
63	50	PPDA 63-10*	171	78	20	125	18	4	M16	3	16	0,9
75	65	PPDA 75-10*	191	92	21	145	18	4	M16	3	16	1,0
90	80	PPDA 90-10 sw	206	110	21	160	18	8	M16	3	16	1,2
110	100	PPDA 110-10 sw	226	133	22	180	18	8	M16	3	16	1,5
140	125	PPDA 140-10 sw	261	167	26	210	18	8	M16	3	16	1,9
160	150	PPDA 160-10 sw	296	190	28	240	22	8	M20	3	16	2,6
225	200	PPDA 225-10 sw	350	250	23	295	22	8	M20	3	10	2,7
250	250	PPDA 250-10 sw	403	277	35	350	22	12	M20	4	10	5,3
280	250	PPDA 280-10 sw	403	310	31	350	22	12	M20	4	10	3,8
315	300	PPDA 315-10 sw	458	348	37	400	22	12	M20	4	10	5,7

\*These sizes are identical to standard PPDA (see page 3)

**ANSI B16.5  
class 150,  
ID metric**



■ Polypropylene  
■ Ductile Iron

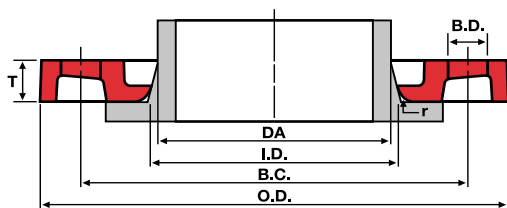

## Polypropylene Encapsulated Ductile Iron (PP/Steel)

**Description** PP encapsulated Ductile Iron Deltaflex® convoluted flange. Available in HDG

Utilises the IPP Deltaflex® flange cross section, highly corrosion resistant.

**Utilisation** For use on PVC-U, PVC-C, ABS, PE, PP, PVDF **socket (63mm) and butt welding stub ends**

**Materials** Glass reinforced Polypropylene (black) with IPP Deltaflex® Ductile Iron insert (GGG 40, DIN 1693)

**Connecting Dimensions** Drilled to ANSI B16.5 class 150, ID for metric pipe B16.47 class 150 series A and AWWA C207

**Must use appropriate washers with the Flanges**

DA	DN	Code	Outside Dia.	Inside Dia.	Flange Thickness	Bolt Circle	Bolt Hole	Bolt Count	Bolt Size	Radius	Operating Pressure	Weight
(mm)	(inches)		O.D.	I.D.	T	B.C.	B.D.	N	M	r	max. [bar]	kg/pc.
63	2"	PPDI 63-2"	164	78	18	121	19	4	M16	4	16	0,8
90	3"	PPDI 90-3"	196	108	19	153	19	4	M16	4	16	1,0
110	4"	PPDI 110-4"	237	128	25	191	19	8	M16	4	16	1,8
160	6"	PPDI 160-6"	297	178	30	242	22	8	M20	4	16	3,2
180	6"	PPDI 180-6"	297	188	30	241.5	22	8	M20	4	16	3,2
225	8"	PPDI 225-8"	354	238	34	299	22	8	M20	4	16	5,1
250	10"	PPDI 250-10"	425	288	38	362	26	12	M20	4	16	6,9
315	12"	PPDI 315-12"	497	338	51	432	26	12	M20	6	16	12,8
355	14"	PPDI 355-14"	542	376	52	476.5	29	12	M26	6	16	15,6
400	16"	PPDI 400-16"	607	430	62	540	29	16	M26	6	16	26,1
450	18"	PPDI 450-18"	648	516	62	578	32	16	M28	6	16	22,1
500	20"	PPDI 500-20"	711	530	68	635	32	20	M28	6	16	36,3
560	22"	PPDI 560-22"	770	615	81	692	35	20	M32	6	16	38,8
630	24"	PPDI 630-24"	826	645	81	749.5	35	20	M32	6	16	56,0
710	28"	PPDI 710-28"	945	737	99	863.5	35	28	M32	6	16	92,3
800	32"	PPDI 800-32"	1087.9	840	157	977.9	41.3	28	M39	6	16	196,7
900	36"	PPDI 900-36"	10202.3	944	173	1085.9	41.4	32	M39	6	16	275,5

These are 'cross-over' flanges for fitting ANSI drilled pumps, valves and fittings to metric standard pipe

Epoxy coated flanges up to 66"

## Thermoplastic Rilsan Coated Deltaflex®

**Description** Thermoplastic Rilsan coated Deltaflex® convoluted flange, highly corrosion, rust and chemical resistant. Specifically designed for use in water, seawater and mining applications. Coating WRAS/DVGW/KTW/NSF approved.

**Utilisation** For use on PE, PP, PVDF butt welding stub ends.

**Material** Ductile Iron (GGG 40)

**Connecting Dimensions** Drilled to ISO/DIN 2501  
Drilled PN10 and PN16 (EN1092)

**Finish** Rilsan coating



■ Thermoplastic Coated  
■ Ductile Iron

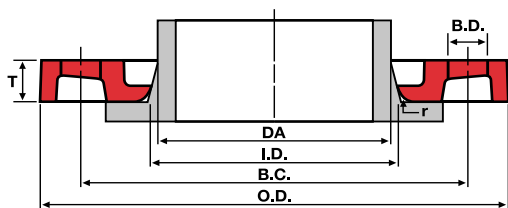

DA (mm)	DN (mm)	Code	Outside Dia. O.D.	Inside Dia. I.D.	Flange Thickness T	Bolt Circle B.C.	Bolt Hole B.D.	Bolt Count N	Bolt Size M	Radius r	Operating Pressure max. [bar]	Weight kg/pc.
50	40	PL2DI 50-10*	150	62	16	110	18	4	M16	3	16	1,0
63	50	PL2DI 63-10*	165	78	16	125	18	4	M16	3	16	1,1
75	65	PL2DI 75-10*	185	92	16	145	18	4	M16	3	16	1,4
90	80	PL2DI 90-10*	200	108	19	160	18	8	M16	3	16	1,6
110	100	PL2DI 110-10*	220	128	19	180	18	8	M16	3	16	1,8
125	100	PL2DI 125-10*	220	135	19	180	18	8	M16	3	16	1,7
140	125	PL2DI 140-10*	250	158	19	210	18	8	M16	3	16	2,1
160	150	PL2DI 160-10*	285	178	19	240	22	8	M20	3	16	2,6
180	150	PL2DI 180-10*	285	188	19	240	22	8	M20	3	16	2,5
200	200	PL2DI 200-16	340	235	23	295	22	12	M20	4	16	4,0
225	200	PL2DI 225-16	340	238	23	295	22	12	M20	3	16	3,9
250	250	PL2DI 250-16	405	288	29	355	26	12	M24	3	16	6,6
280	250	PL2DI 280-16	405	294	29	355	26	12	M24	3	16	6,5
315	300	PL2DI 315-16	460	338	34	410	26	12	M24	3	16	8,6
355	350	PL2DI 355-16	520	376	39	470	26	16	M24	4	16	14,4
400	400	PL2DI 400-16	580	430	43	525	30	16	M27	4	16	17,0
450	500	PL2DI 450-16	715	517	46	650	33	20	M30	6,5	16	27,0
500	500	PL2DI 500-16	715	533	46	650	33	20	M30	7	16	24,4
560	600	PL2DI 560-16	840	618	55	770	36	20	M33	6	16	36,2
630	600	PL2DI 630-16	840	645	55	770	36	20	M33	6	16	43,4

## Epoxy Coated Ductile Iron (GGG 40) Pipe flange (drilled to PN10)



**Description** Black epoxy coated or HDG Deltaflex® convoluted flange

Utilises the IPP Deltaflex® flange cross section.

**Utilisation** For use on PE, PP, PVDF butt welding stub ends.

**Material** Ductile Iron (GGG 40)

**Connecting Dimensions** Drilled to ISO/DIN 2501  
Drilled to PN 16 to DA 180 (EN1092).  
Drilled to PN 10 (EN1092)  
DA 180 to DA 1600

**Finish** Fusion bonded epoxy coating to EN14901-2014 or hot dip galvanized



■ Black Epoxy or Galvanised  
■ Ductile Iron

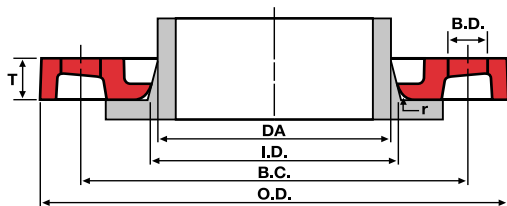

DA (mm)	DN (mm)	Code	Outside Dia. O.D.	Inside Dia. I.D.	Flange Thickness T	Bolt Circle B.C.	Bolt Hole B.D.	Bolt Count N	Bolt Size M	Radius r	Operating Pressure max. [bar]	Weight kg/pc.
50	40	DF2DI 50-10	150	62	16	110	18	4	M16	3	16	1,0
63	50	DF2DI 63-10	165	78	16	125	18	4	M16	3	16	1,1
75	65	DF2DI 75-10	185	92	16	145	18	4	M16	3	16	1,4
90	80	DF2DI 90-10	200	108	19	160	18	8	M16	3	16	1,6
110	100	DF2DI 110-10	220	128	19	180	18	8	M16	3	16	1,8
125	100	DF2DI 125-10	220	135	19	180	18	8	M16	3	16	1,7
140	125	DF2DI 140-10	250	158	19	210	18	8	M16	3	16	2,1
160	150	DF2DI 160-10	285	178	19	240	22	8	M20	3	16	2,6
180	150	DF2DI 180-10	285	188	19	240	22	8	M20	3	16	2,5
200	200	DF2DI 200-10	340	235	18	295	22	8	M20	3	10	3,5
225	200	DF2DI 225-10	340	238	18	295	22	8	M20	3	10	3,5
250	250	DF2DI 250-10	395	288	22	350	22	12	M20	3	10	5,3
280	250	DF2DI 280-10	395	294	22	350	22	12	M20	3	10	5,1
315	300	DF2DI 315-10	445	338	26	400	22	12	M20	3	10	6,6
355	350	DF2DI 355-10	505	376	30	460	22	16	M20	4	10	11,3
400	400	DF2DI 400-10	565	430	34	515	26	16	M24	4	10	14,2
450	500	DF2DI 450-10	670	517	42	620	26	20	M24	6	10	21,5
500	500	DF2DI 500-10	670	533	38	620	26	20	M24	4	10	18,7
560	600	DF2DI 560-10	785	618	50	725	30	20	M27	7	10	34,8
630	600	DF2DI 630-10	785	645	40	725	30	20	M27	4	10	26,4
710	700	DF2DI 710-10	900	740	45	840	30	24	M27	5	6	36,4
800	800	DF2DI 800-10	1015	843	53	950	33	24	M30	5	6	50,5
900	900	DF2DI 900-10	1115	947	56	1050	33	28	M30	5	6	55,8
1000	1000	DF2DI 1000-10	1230	1050	62	1160	36	28	M33	5	6	71,1
1200	1200	DF2DI 1200-10	1455	1260	68	1380	39	32	M36	6	4	101,0
1400	1400	DF2DI 1400-10	1675	1441	72	1590	42	36	M39	6	4	143,0
1600	1600	DF2DI 1600-10	1915	1644	84	1820	48	40	M45	6	4	203,0



## Epoxy Coated Ductile Iron (GGG 40) Pipe flange (drilled to PN16)



**Description** Black epoxy coated or HDG Deltaflex® convoluted flange

Utilises the IPP Deltaflex® flange cross section.

**Utilisation** For use on PE, PP, PVDF butt welding stub ends.

**Material** Ductile Iron (GGG 40)

**Connecting Dimensions** Drilled to ISO/DIN 2501  
Drilled PN 16 (EN1092)

**Finish** Fusion bonded epoxy coating to EN14901-2014 or hot dip galvanized



■ Black Epoxy or Galvanised  
■ Ductile Iron

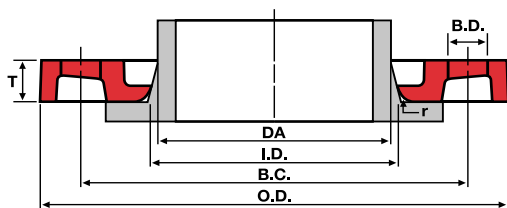

DA (mm)	DN (mm)	Code	Outside Dia. O.D.	Inside Dia. I.D.	Flange Thickness T	Bolt Circle B.C.	Bolt Hole B.D.	Bolt Count N	Bolt Size M	Radius r	Operating Pressure max. [bar]	Weight kg/pc.
50	40	DF2DI 50-10*	150	62	16	110	18	4	M16	3	16	1,0
63	50	DF2DI 63-10*	165	78	16	125	18	4	M16	3	16	1,1
75	65	DF2DI 75-10*	185	92	16	145	18	4	M16	3	16	1,4
90	80	DF2DI 90-10*	200	108	19	160	18	8	M16	3	16	1,6
110	100	DF2DI 110-10*	220	128	19	180	18	8	M16	3	16	1,8
125	100	DF2DI 125-10*	220	135	19	180	18	8	M16	3	16	1,7
140	125	DF2DI 140-10*	250	158	19	210	18	8	M16	3	16	2,1
160	150	DF2DI 160-10*	285	178	19	240	22	8	M20	3	16	2,6
180	150	DF2DI 180-10*	285	188	19	240	22	8	M20	3	16	2,5
200	200	DF2DI 200-16	340	235	23	295	22	12	M20	4	16	4,0
225	200	DF2DI 225-16	340	238	23	295	22	12	M20	3	16	3,9
250	250	DF2DI 250-16	405	288	29	355	26	12	M24	3	16	6,6
280	250	DF2DI 280-16	405	294	29	355	26	12	M24	3	16	6,5
315	300	DF2DI 315-16	460	338	34	410	26	12	M24	3	16	8,6
355	350	DF2DI 355-16	520	376	39	470	26	16	M24	4	16	14,4
400	400	DF2DI 400-16	580	430	43	525	30	16	M27	4	16	17,0
450	500	DF2DI 450-16	715	517	46	650	33	20	M30	6,5	16	27,0
500	500	DF2DI 500-16	715	533	46	650	33	20	M30	7	16	24,4
560	600	DF2DI 560-16	840	618	55	770	36	20	M33	6	16	36,2
630	600	DF2DI 630-16	840	645	55	770	36	20	M33	6	16	43,4

\*These sizes are identical to those shown on page 7

# PPFL Flanges

## d32-d630 PN10 Polypropylene Encapsulated flat flange

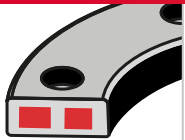

■ Polypropylene  
■ Steel

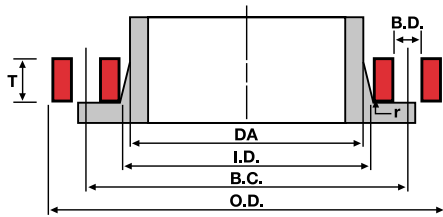

- Description** PP encapsulated Steel flanges, highly corrosion resistant.
- Utilisation** For use on PE, PP, PVDF butt welding stub ends.
- Materials** Glass reinforced Polypropylene (black) with Steel insert
- Connecting** Drilled to ISO/DIN 2501 (EN1092) standard
- Dimensions** DA 32-d180mm: drilled PN 10/16  
> DA 180mm: drilled PN10

**Must use appropriate washers with the Flanges**

DA (mm)	DN (mm)	Code	Outside Dia. O.D.	Inside Dia. I.D.	Flange Thickness T	Bolt Circle B.C.	Bolt Hole B.D.	Bolt Count N	Bolt Size M	Radius r	Operating Pressure max. [bar]	Weight kg/pc.
32	25	PPFL 32-10	116	42	16	85	14	4	M12	3	16	0.6
40	32	PPFL 40-10	140	51	16	100	18	4	M16	3	16	0.7
50	40	PPFL 50-10	150	62	19	110	18	4	M16	3	16	1.1
63	50	PPFL 63-10	165	78	19	125	18	4	M16	3	16	1.2
75	65	PPFL 75-10	185	92	20	145	18	4	M16	3	16	1.6
90	80	PPFL 90-10	201	108	20	160	18	8	M16	3	16	1.7
110	100	PPFL 110-10	221	128	20	180	18	8	M16	3	16	1.8
125	100	PPFL 125-10	221	135	20	180	18	8	M16	3	16	1.8
140	125	PPFL 140-10	252	158	22	210	18	8	M16	3	16	2.6
160	150	PPFL 160-10	286	178	24	240	22	8	M20	3	16	3.5
180	150	PPFL 180-10	286	188	24	240	22	8	M20	3	16	3.5
200	200	PPFL 200-10	342	235	24	295	22	8	M20	3	10	4.4
225	200	PPFL 225-10	342	238	24	295	22	8	M20	3	10	4.4
250	250	PPFL 250-10	400	288	30	350	22	12	M20	3	10	7.5
280	250	PPFL 280-10	400	294	30	350	22	12	M20	3	10	7.5
315	300	PPFL 315-10	455	338	30	400	22	12	M20	3	10	9.2
355	350	PPFL 355-10	510	376	34	460	22	16	M20	3	10	14.5
400	400	PPFL 400-10	570	430	37	515	26	16	M24	3	10	19.2
450	500	PPFL 450-10	675	518	44	620	26	20	M24	3	10	27.3
500	500	PPFL 500-10	675	530	44	620	26	20	M24	3	10	24.5
560	600	PPFL 560-10	788	619	50	725	30	20	M27	3	10	38.1
630	600	PPFL 630-10	788	645	50	725	30	20	M27	3	10	34.4

# A strong customer connection

## We are trusted worldwide by leading companies

IPP is the most trusted name in the industry, having helped thousands of customers worldwide reduce costs and increase the performance and safety of their flanging systems.

## Have a project? Send us your requirements.

We do absolutely everything possible to meet your requirements and we are even flexible enough to source non standard products. We endeavour to get quotations back to you within 24hrs.



[info@ippdeltaflex.com](mailto:info@ippdeltaflex.com)



IPP recommends the following procedures to ensure a reliable and tight IPP Deltaflex® flange joint

### Alignment

1. The sealing faces of the two stub-ends in a joint should contact each other, or in the case of rubber gasketed joint, they should be parallel to each other all around the circumference and in full contact (see lines A–A, B–B, C–C in Fig. 1 and 2).
2. The IPP Deltaflex® flange face D–D (see Fig. 3) should be in full contact with the upper face of the stub-end all around the circumference to avoid fulcrum effect, which will lead to leaking and even breaking of the flange itself while torquing the bolts

### Bolt Tightening

1. Install all the bolts and nuts finger-tight, ensuring at all times that the alignment conforms to figures 1, 2, and 3.
2. As the first torquing step, tighten the bolts in a crisscross sequence as shown in Fig. 4. Using a torque wrench with 20% of the final torque listed in the table on the other side of this sheet, taking care that points (I) and (II) are satisfied at all times.
3. In the four remaining steps, repeat step two four times, each time increasing the torque by 20% of the final value.

4. After reaching the final torque, use rotational tightening until all bolts are stable at the final torque value (in general, two complete times around is required).

### Always use the crisscross pattern!

Caution! Do not use this procedure to align and/or pull the joint together.

This document reports accurate and reliable information to the best of our knowledge, but our suggestions and recommendations cannot be guaranteed because the conditions of use are beyond our control. Improved Piping Products (IPP) assumes no responsibility for the use of information presented herein and hereby disclaims all liability in regard to such use.

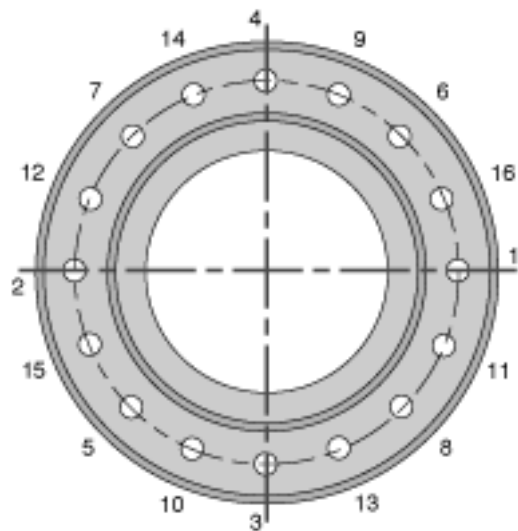

Fig.4 Tightening Sequence

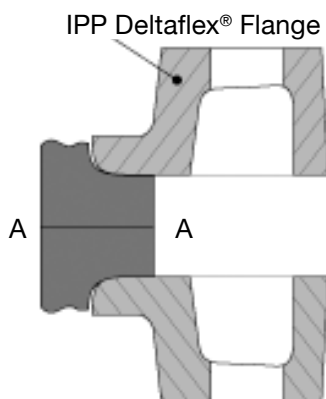

Fig.1 HDPE Stub-end

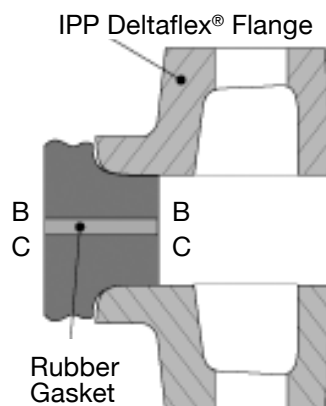

Fig.2 Steel Stub-end

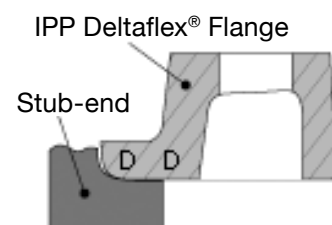

Fig.3

Metric Nominal Pipe Size (mm)	Number of Bolts	Initial Minimum Lubed Torque (N/M)	Initial Maximum Lubed Torque (N/M)
50/63	4	30	43
75/90	4	41	61
110	8	41	61
125	8	60	89
160/180	8	60	89
200/225	8	79	119
250	12	79	119
315	12	102	155
355	12	190	285
400	16	190	285
450	16	190	285
500	20	190	285
560	20	217	325
630	20	244	366
710	24	244	366
800	24	325	488
900	32	353	529
1000	36	420	630
1200	44	420	630
1600	44	495	746

For additional details, download the Plastic Pipe Institute's (PPI) TN-38, bolt torque for polyethylene flanged joints bulletin (PDF).

[http://ipp-inc.com/Libraries/Product\\_Catalogs/tn-38\\_bolt\\_torque\\_flanged\\_joints.sflb.aslx](http://ipp-inc.com/Libraries/Product_Catalogs/tn-38_bolt_torque_flanged_joints.sflb.aslx)





Sales office in United Kingdom

email [info@ippdeltaflex.com](mailto:info@ippdeltaflex.com)  
phone **+44 (0) 7903 098 464**  
web [www.ippdeltaflex.com](http://www.ippdeltaflex.com)

---

